

MRS BAUSTRASSE

Rental|Sales|Service

► Mobile Road Systems

| MRS - Light B |

Ø 22 mm
(Quick connect function)

2.88 m²
Usable area
per panel

Handle
(on all sides)

Profil 2,5 mm

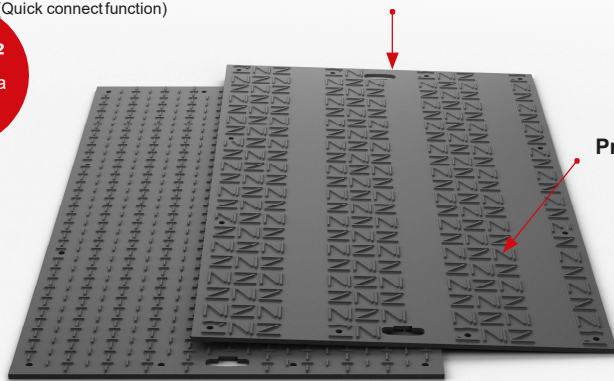

► Properties

The **MRS - light** is extremely flexible and elastic, adapts perfectly to the respective surface and protects sensitive surfaces.

Material: polyethylene, high molecular weight

Dimensions: 2000 x 1200 x 17 mm (including profile)

Weight per panel: approx. 32 kg

Surface / colour: 2.5 mm profile on one side / black-coloured

Load capacity: approx. 80 t (depending on the ground conditions)

Transport per truck: 700 units (1.680 m²)



Road construction and
access routes



Concerts
and events



Temporary
walkways



Mobile
logistics



Mobile crane
working spaces



Mobile
parking spaces



Tent floors

■ The panels can be used as a temporary **access road** or **parking lot** for tons of wheel load.

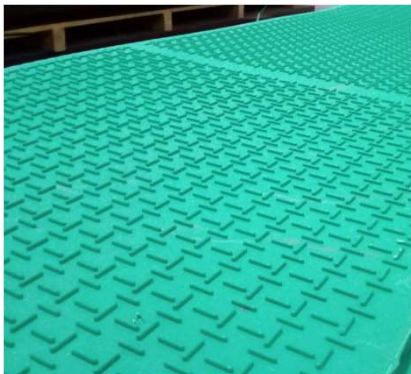

M: +49 176 11007755

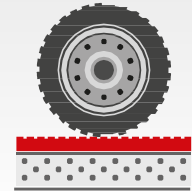

► Accessories

MRS - Light B Accessories

The **MRS - Light Ground Protection Panels** are equipped with the new, **2-way connectors** made entirely of metal and **M10 screws** connected.

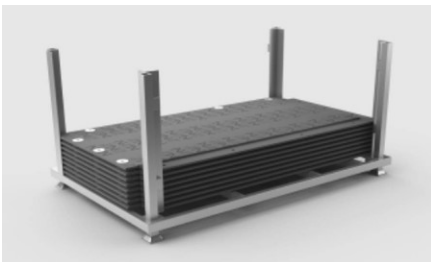

Symbol photo

■ Stacking Rack MRS Light

The stacking rack pallets are flexible and stackable storage systems.

Weight: 105 kg

Order No.: 50 901 000

(30 panels per pallet)



■ Metal Double Connectors

completely made of metal

Weight: 0.3 kg

Order No.: 50 300 001

(60 pieces per pallet /

4 pieces per panel)



■ M10 Screws / Washers

Commercially available screws are used with all products.

Weight: 0.032 kg (incl. washer)

Order No.: 50 900 002

(120 pieces per pallet /

2 pieces per panel)



General information

Unloading:

The panels can be unloaded from a lorry using a forklift truck or a crane. When lifting, special care must be taken to ensure that the panels cannot slip or fall off.

Storage: Never stack more than 30 panels on a pallet.

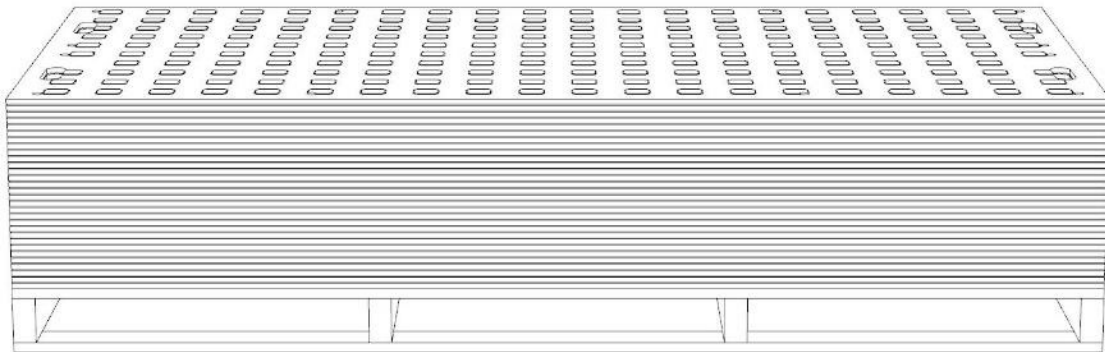

Storage: Never stack more than 25 panels on a stake rack.

Do not move more than 2 stake racks at a time using a forklift truck.

Move only one stake rack at a time using a chain sling.

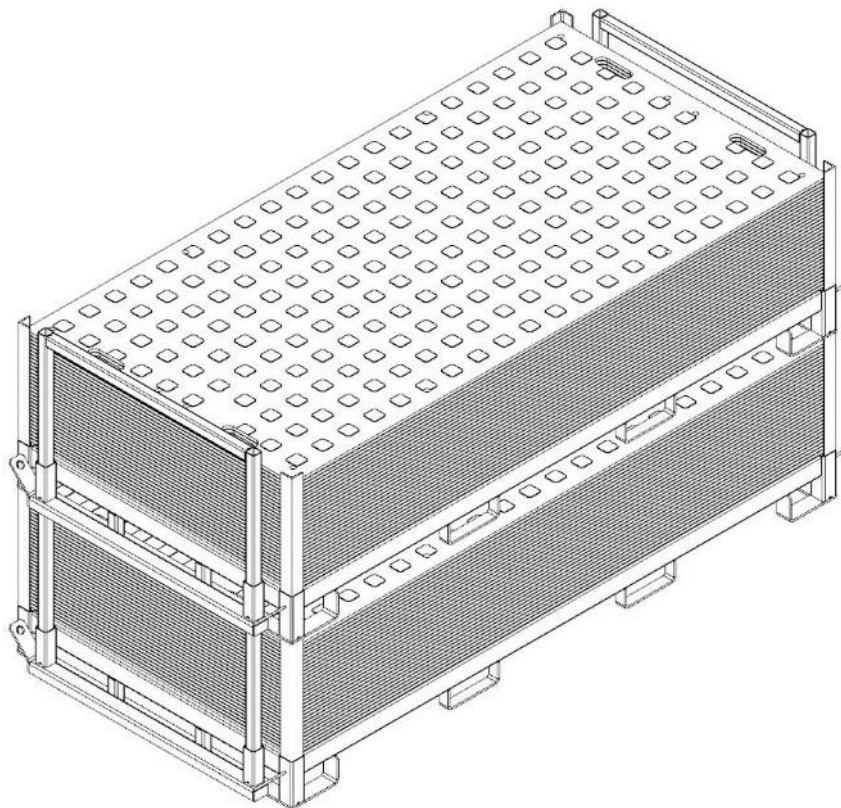

Use of the panels:

The upper side is engineered with approx. 5 mm high nubs.

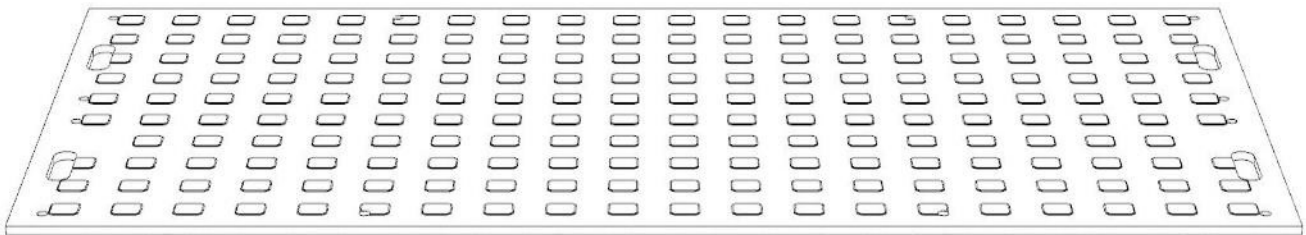

Use of the panels:

The underside is striated/roughened.

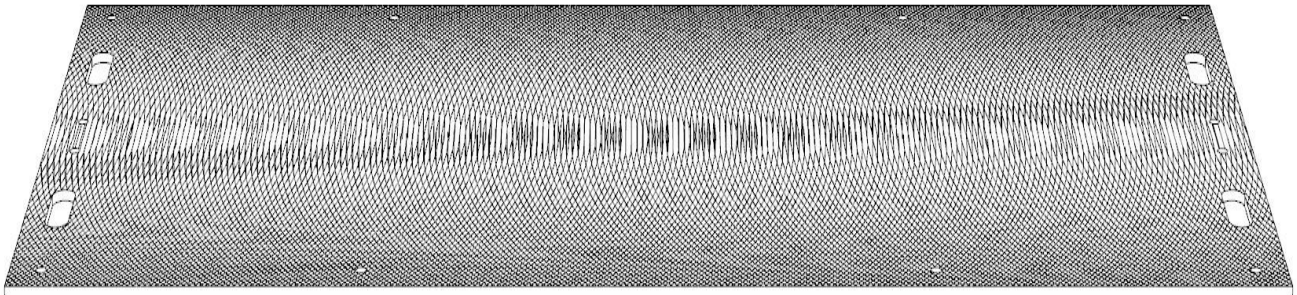

Connecting 2 panels:

Connect and screw the panels using the 2-way metal connector, 2 washers and 2 hexagonal screws (M10x16mm). All adjacent panels must be connected in this way.

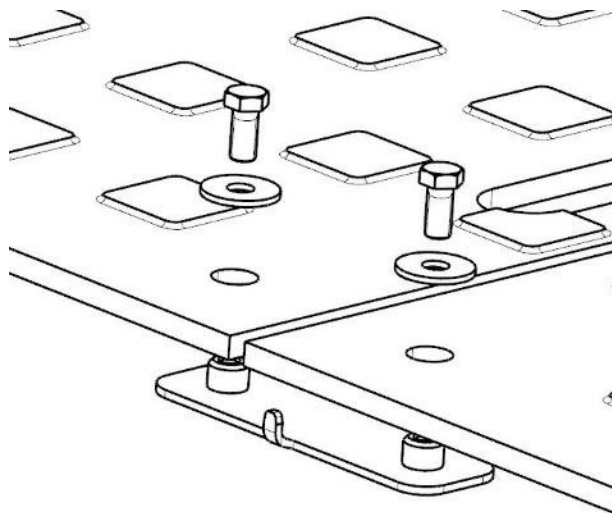

Connecting 4 panels:

Connect and screw the panels using the 4-way metal connector, 4 washers and 4 hexagonal screws (M10x16mm). All adjacent panels must be connected in this way.

